

Supplément N° 4. Mise à jour au 31. 12. 1972.
Nachtrag Nr. 4. Stand am 31. 12. 1972.
Supplement No 4. Brought up to date the 31. 12. 1972.
Suplemento N.º 4. Puesto al corriente el 31. 12. 1972.
Suplemento N° 4. Pôsto em dia 31. 12. 1972.
Supplemento No 4. Aggiornamento al 31. 12. 1972.

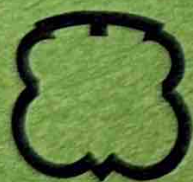

EBAUCHES SA

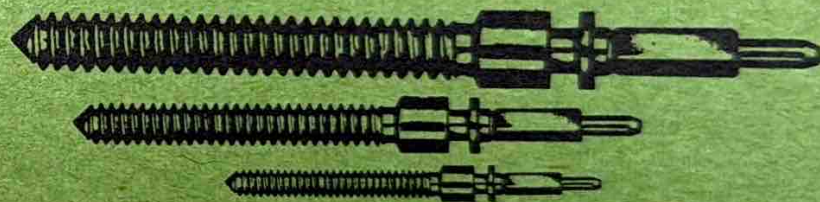

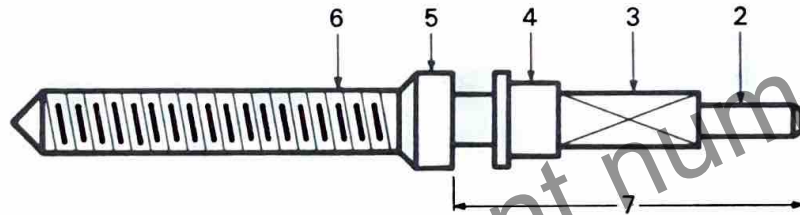

2001 NEUCHATEL SUISSE

Tiges positives
Positive Wellen
Positive stems
Tijas positivas
Tiges positivas
Alberi positivi

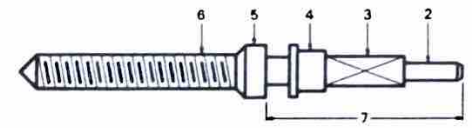

Document numérisé
et mis à disposition
sur plongheure.com



1	2	3	4	5	6	7	8
	mm	mm	mm	mm	mm	mm	
							
2066							2061
2086							2061
							
691							60
							
8151							8100
8155							8100
8157							8100
8430							8422
8431							8422
8827							8800
8837							8800
							
691							69

Document numérisé
et mis à disposition
sur plongheure.com

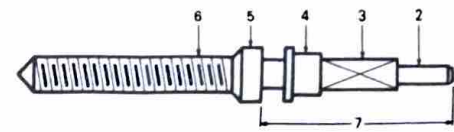

1	2	3	4	5	6	7	8
	mm	mm	mm	mm	mm	mm	
1977-2							1977
7425-1							7410 (2 ^e)
7426-1							7410 (2 ^e)
7427-1							7410 (2 ^e)
7428-1							7410 (2 ^e)
7525-1							7410 (2 ^e)
7526-1							7410 (2 ^e)
7527-1							7410 (2 ^e)
7528-1							7410 (2 ^e)
374	0,50	0,64	0,80	1,20	0,90	5,14	378 FHF 37
378							374

Tiges du type bascule
Wippkloben-Wellen
Rocking-bar type stems
Tijas tipo báscula
Tiges tipo báscula
Alberi tipo bascula

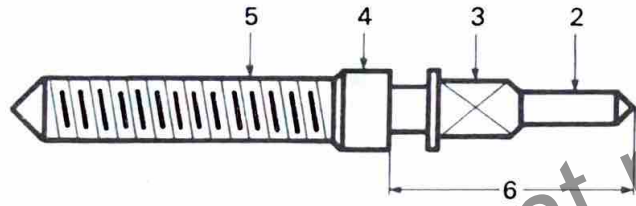

Document numérisé
et mis à disposition
sur plongheure.com

Tiges spéciales
Sonderwellen
Special stems
Tijas especiales
Tiges especiais
Alberi speciali

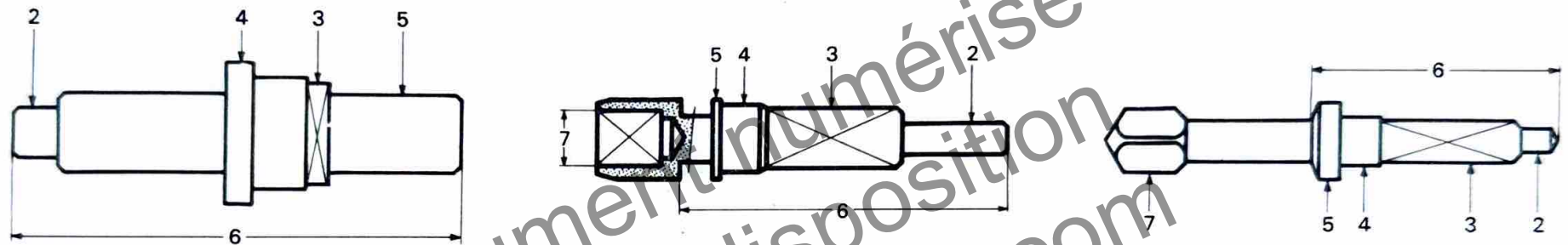

Particolarità:

Page 5.4, cal. Valjoux, les numéros entre parenthèses représentent le genre de l'exécution.

Besonderheit:

Seite 5.4, Kaliber Valjoux, die Nummern in Klammer stellen die Art der Ausführung dar.

Particularity:

Page 5.4, calibre Valjoux, the numbers in parentheses show the kind of execution.

Particularidad:

Página 5.4, calibre Valjoux, los números entre parentesis representan el genero de l'ejecución.

Particularidade:

Página 5.4, calibre Valjoux, os números entre parêntesis indicam o género da execução.

Particolarità:

Página 5.4, calibre Valjoux, i numeri tra parentesi rappresentano il genere dell'esecuzione.

Tiges fendues
Geschlitzte Wellen
Split stems
Tijas hendidas
Tiges fendidas
Alberi spaccati

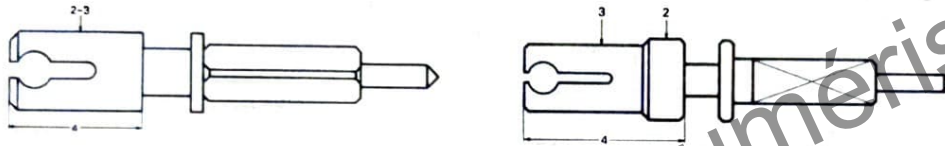

Document numérisé
et mis à disposition
sur plongheure.com

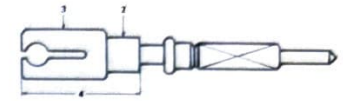
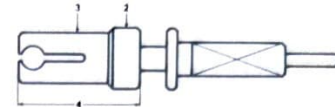
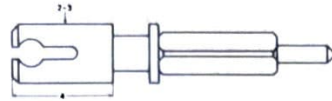

1	2	3	4	5			1	2	3	4	5		
	mm	mm	mm					mm	mm	mm			
2061	120	120	305	2063	2064	2066	2734				2600		
				2074	2076	2086	2763	120	120	370	2764	2766	2769
				2161	2163	2164					2783	2784	2789
				2166	2174	2176					2790		
2063				2061									
2064				2061			2764				2763		
2066				2061			2766				2763		
2074				2061			2769				2763		
2076				2061			2783				2763		
2086				2061			2784				2763		
2161				2061			2789				2763		
2163				2061			2790				2763		
2164				2061									
2166				2061									
2174				2061									
2176				2061									

Document numérisé
 et mis à disposition
 sur plongeur.com

Tiges à bec
Wellen mit Zunge
Beaked stems
Tijas de pico
Tiges de bico
Alberi a becco

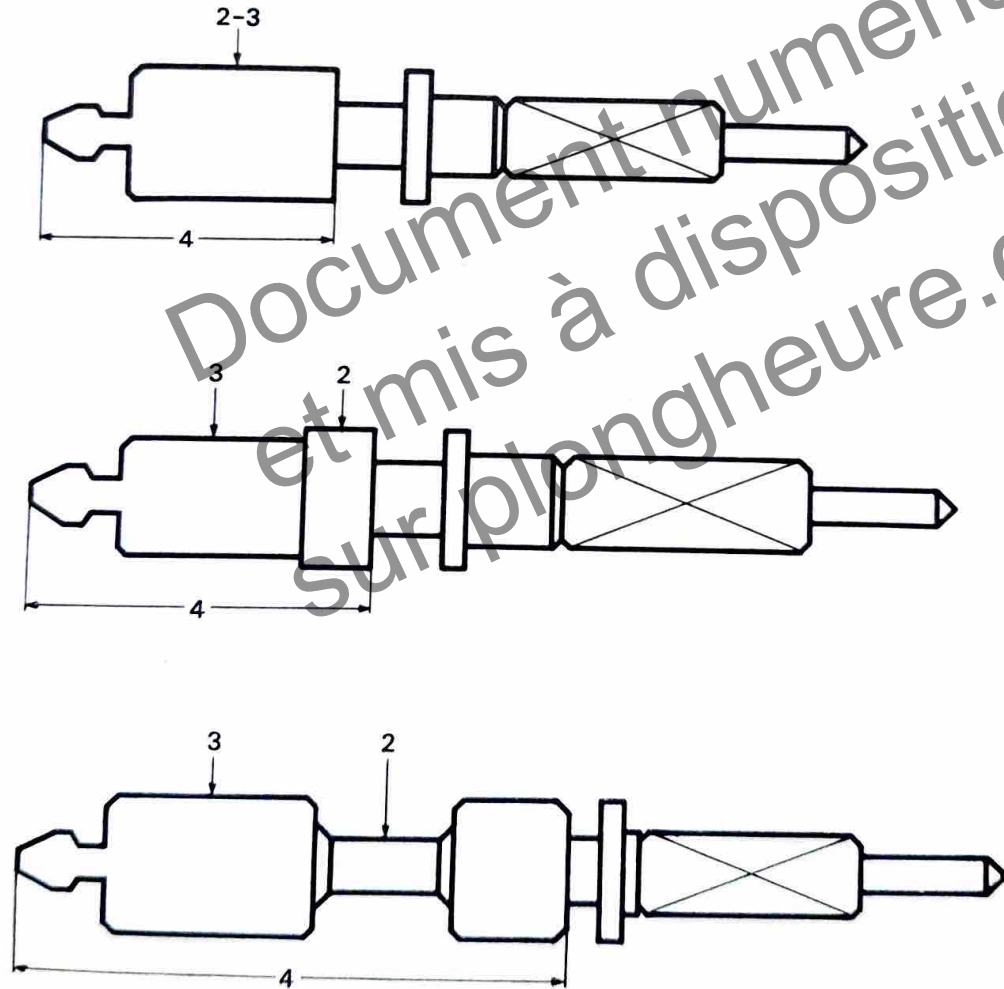

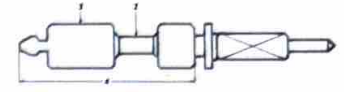
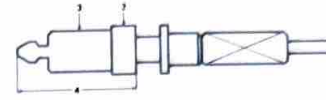
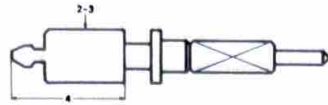

1	2	3	4	5			1	2	3	4	5		
	mm	mm	mm					mm	mm	mm			
2061	120	120	230	2063	2064	2066	60	130	120	226	60 N	60-1	60-2
				2074	2076	2086					60-2 N	60-21	69
				2161	2163	2164					69-21	691	ST 69
				2166	2174	2176	60 N						
2063				2061			60-1						
2064				2061			60-2						
2066				2061			60-2 N						
2074				2061			60-21						
2076				2061			69						
2086				2061			69-21						
2161				2061			691						
2163				2061									
2164				2061									
2166				2061									
2174				2061									
2176				2061									

Document numérisé
et mis à disposition
sur plongheure.com

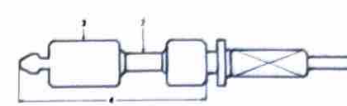
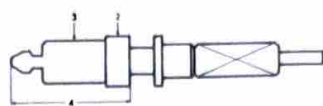
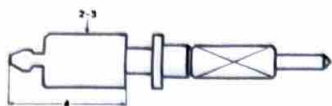

1	2	3	4	5			1	2	3	4	5		
	mm	mm	mm					mm	mm	mm			
2641	110	110	210	2648 2661 2678	2651 2668	2658 2671	2800	110	110	295	2801 2821	2819 2839	2820
							2801				2800		
2648				2641			2802	110	110	295	2804 2810 2824 2830	2806 2812 2826 2832	2808 2822 2828
2651				2641									
2658				2641									
2661				2641			2804				2802		
2668				2641			2806				2802		
2671				2641			2808				2802		
2678				2641			2810				2802		
2763	120	120	295	2764 2783 2790	2766 2784	2769 2789	2812				2802		
							2819				2800		
2764				2763			2820				2800		
2766				2763			2821				2800		
2769				2763			2822				2802		
2783				2763			2824				2802		
2784				2763			2826				2802		
2789				2763			2828				2802		
2790				2763			2830				2802		

