

Supplément N° 3. Mise à jour au 31. 12. 1971. Remplace N°s 1 et 2.

Nachtrag Nr. 3. Stand am 31. 12. 1971. Die Nrn. 1 und 2 ersetzen.

Supplement No 3. Brought up to date the 31. 12. 1971. Replace the No 1 and 3.

Suplemento N.º 3. Puesto al corriente el 31. 12. 1971. Reemplazar los N.ºs 1 y 2.

Suplemento N° 3. Pôsto em dia 31. 12. 1971. Substituir N° 1 + N° 2.

Supplemento No 3. Aggiornamento al 31. 12. 1971. Sostituire i Ni 1 e 2.



EBAUCHES SA
2001 NEUCHÂTEL SUISSE

Classification des tiges par longueur active
Einteilung der Aufzugswellen nach der aktiven Länge
Classification of stems according to their active length
Clasificación de las tijas según longitud activa
Classificação das tiges pelo comprimento activo
Classificazione degli alberi per la loro lunghezza attiva

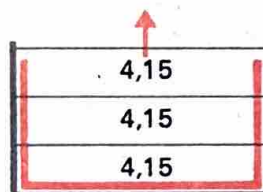

4,15	AS	1051
4,15	ETA	2360
4,15	ETA	2410

Document numérisé
et mis à disposition
sur plongheure.com



1	2	3	1	2	3
mm 1,60	ESA	9154	mm 5,70	AS	2060
4,07	ETA	2640	5,83	AS	1916
4,13	ETA	2641	6,02	FHF	97
4,20	INT D	1977	6,02	ST	97
4,25	EB	8422	11,40	ESA	9130
4,40	A	7326	14,80 (3)	RF	7720
4,70	FEF	6630	15,40 (4)	RF	7720
4,84	INT D	69-21	15,70 (0)	RF	7720
5,01 (1)	INT D	7410	19,40 (5)	RF	7720
5,10	FEF	6670	20,70 (1)	RF	7720
5,14 (2)	INT D	7410	23,70 (2)	RF	7720
5,14	FHF	37	26,70 (7)	RF	7720
5,15	RF	7740	29,70 (6)	RF	7720
5,20	ETA	2750			
5,20	ETA	2763			
5,20	ETA	2800			
5,20	ETA	2802			
5,20	AV	4820			
5,21	RF	7739			
5,53	AS	1920			
5,60	AS	2061			

Tiges positives
Positive Wellen
Positive stems
Tijas positivas
Tiges positivas
Alberi positivi

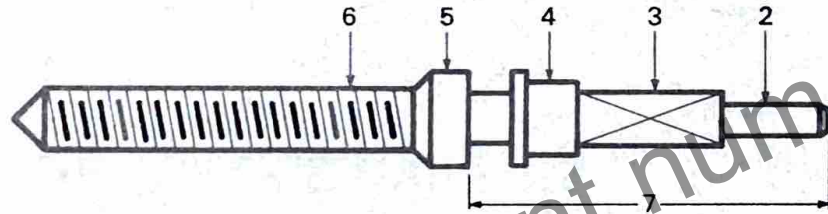

Document numérisé
et mis à disposition
sur plongheure.com

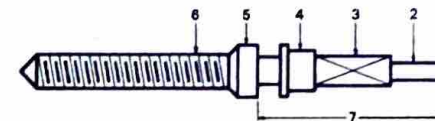

1	2	3	4	5	6	7	8					
	mm	mm	mm	mm	mm	mm						
1911							1916					
1913							1916					
1914							1916					
1916	0,49	0,73	0,92	1,19	0,90	5,83	1911	1913	1914			
1920	0,40	0,55	0,70	1,10	0,90	5,53						
1930							1475 (+REV)					
1931							1475 (+REV)					
1977							1012					
1978							1012					
1981							1831					
1983							1831					
1985							1831					
1986							1831					
1993							1831					
1995							1831					
1996							1831					
2060	0,50	0,74	0,93	1,20	0,90	5,70	2062	2066	2160	2162		
2061	0,50	0,74	0,93	1,20	0,90	5,60	2063 2163	2064 2164	2074 2166	2076 2174	2161 2175	2176
2062							2060					

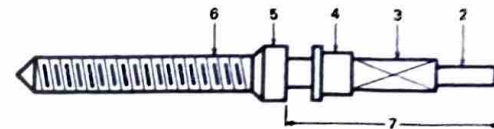

1	2	3	4	5	6	7	8
	mm	mm	mm	mm	mm	mm	
2063							2061
2064							2061
2066							2060
2074							2061
2076							2061
2160							2060
2161							2061
2162							2060
2163							2061
2164							2061
2166							2061
2174							2061
2176							2061

Document numérisé
 et mis à disposition
 sur plongheure.com

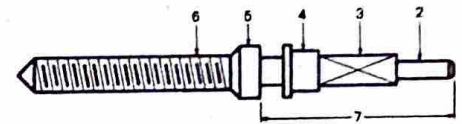

1	2	3	4	5	6	7	8	
	mm	mm	mm	mm	mm	mm		
37	0,50	0,64	0,80	1,20	0,90	5,14	374	378
90-4							90-5	
90-9							90-5	
97	0,50	0,80	1,02	1,40	0,90	6,02	974	ST 97
351							34	
352							34	
374							37	
378							37	
905							90-5	
908							90-5	
974							97	

Document numérisé
 et mis à disposition
 sur plongheure.com

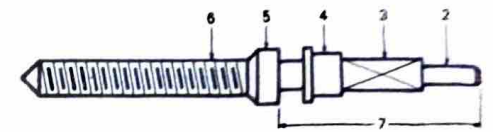

1	2	3	4	5	6	7	8					
	mm	mm	mm	mm	mm	mm						
2551 R							2540					
2612							2600					
2618							2600					
2630							2600					
2632							2600					
2640	0,40	0,50	0,63	1,10	0,90	4,07	2650 2660 2670					
2650							2640					
2660							2640					
2670							2640					
2722							2600					
2724							2600					
2728							2600					
2732							2600					
2734							2600					
2738							2600					
2750	0,50	0,73	0,90	1,20	0,90	5,20	2751 2752 2754 2758 2760 2762 2768 2770 2771 2772 2773 2774 2776 2778 2779 2780 2782 2788					
2751							2750					
2752							2750					
2754							2750					

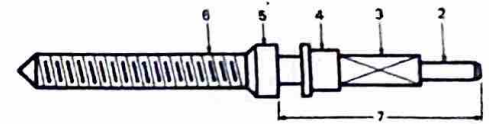

1	2	3	4	5	6	7	8				
	mm	mm	mm	mm	mm	mm					
2758							2750				
2760							2750				
2762							2750				
2768							2750				
2770							2750				
2771							2750				
2772							2750				
2773							2750				
2774							2750				
2776							2750				
2778							2750				
2779							2750				
2780							2750				
2782							2750				
2788							2750				
2800	0,40	0,50	0,63	1,10	0,90	5,20	2801	2819	2820	2821	2839
2801							2800				
2819							2800				
2820							2800				
2821							2800				

Document numérique
et mis à disposition
sur plongheure.com

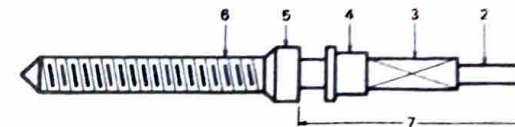

1	2	3	4	5	6	7	8
	mm	mm	mm	mm	mm	mm	
2839							2800
4820	0,40	0,64	0,80	1,20	0,90	5,20	4830
4830							4820
6308							640
6311							176
6311 N							176
6325							176
6326							176
6411							176
6411 N							176
6425							176
6426							176
6487							6360
6488							6360

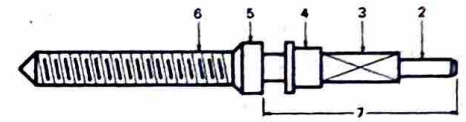

1	2	3	4	5	6	7	8						
	mm	mm	mm	mm	mm	mm							
6621							270						
6630	0,40	0,55	0,70	1,20	0,90	4,70	6631	6700	6701	6710	6711	6720	6721
6631							6630						
6662							370						
6670	0,40	0,64	0,80	1,20	0,90	5,10	6676	6677					
6676							6670						
6677							6670						
6686							400						
6700							6630						
6701							6630						
6710							6630						
6711							6630						
6720							6630						
6721							6630						

Document numérique
et mis à disposition
sur plongheure.com

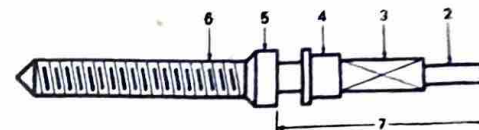

1	2	3	4	5	6	7	8
	mm	mm	mm	mm	mm	mm	
7001							7000
7011							7000
7014							7000
7057							7040
7077							7060

Document numérisé
et mis à disposition
sur plongheure.com

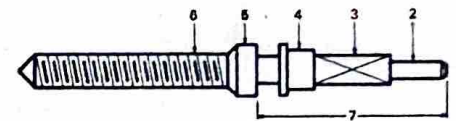

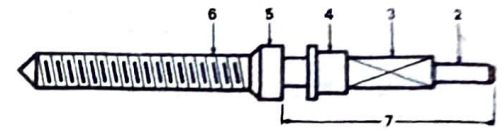

1	2	3	4	5	6	7	8																									
	mm	mm	mm	mm	mm	mm																										
8131							8100																									
8135							8100																									
8137							8100																									
8171							8100																									
8175							8100																									
8177							8100																									
8360							8340-67																									
8364							8340-67																									
8371							8340-67																									
8393-67							8340-67																									
8398							8340-67																									
8422	0,39	0,78	1,00	1,79	1,20	4,25	8423	8428	8429	8450	8451	8454	8455	8456	8460	8461	8464	8465	8466	8467	8480	8481	8484	8485	8486	8487	8490	8491	8494	8495	8496	8497
8423							8422																									
8428							8422																									
8429							8422																									
8450							8422																									
8451							8422																									
8454							8422																									

Document numérisé
et mis à disposition
sur plongheure.com

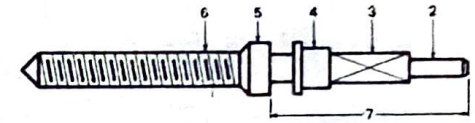

1	2	3	4	5	6	7	8
	mm	mm	mm	mm	mm	mm.	
8455							8422
8456							8422
8460							8422
8461							8422
8464							8422
8465							8422
8466							8422
8467							8422
8480							8422
8481							8422
8484							8422
8485							8422
8486							8422
8487							8422
8490							8422
8491							8422
8494							8422
8495							8422
8496							8422
8497							8422



1	2	3	4	5	6	7	8
	mm	mm	mm	mm	mm	mm	
232							23
234							23
235							23
236							23
237							23
725							23
726							23
729							23
730							23
7732							7730
7733							7730
7734							7730
7736							7730
7739	0,40	0,70	0,88	1,40	1,20	5,21	
7740	0,40	0,70	0,88	1,40	1,20	5,15	
							
97	0,50	0,80	1,02	1,40	0,90	6,02	974 FHF 97
974							97

Document numérisé
et mis à disposition
sur plongheure.com

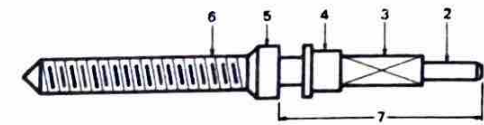



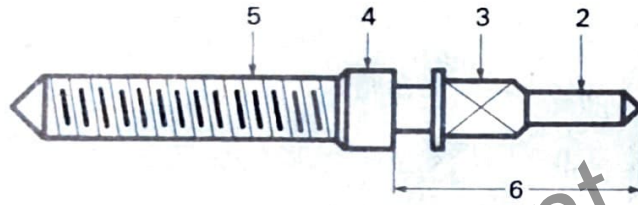

1	2	3	4	5	6	7	8						
	mm	mm	mm	mm	mm	mm							
69-21	0,40	0,60	0,75	1,20	0,90	4,84	FHF 60	INT S 69-21					
75							1977						
1977	0,40	0,56	0,70	1,36	0,90	4,20	75	AS 1012					
7410	0,50	0,65	0,88	1,20	0,90	5,01	7411	7412	7420	7421	7422	7423	
	0,64	0,65	0,88	1,20	0,90	5,14	7424	7425	7426	7427	7428	7520	
							7521	7522	7523	7524	7525	7526	
							7527	7528					
7411							7410						
7412							7410						
7420							7410						
7421							7410						
7422							7410						
7423							7410						
7424							7410						
7425							7410						
7426							7410						
7427							7410						
7428							7410						
7520							7410						
7521							7410						
7522							7410						

Tiges du type bascule
Wippkloben-Wellen
Rocking-bar type stems
Tijas tipo báscula
Tiges tipo báscula
Alberi tipo bascula

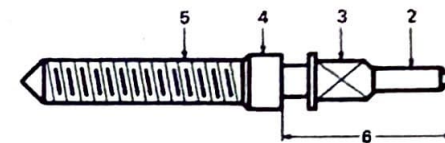

Document numérisé
et mis à disposition
sur plongheure.com



1	2	3	4	5	6	7
	mm	mm	mm	mm	mm	
						
1930						1475 (REV)
1931						1475 (REV)
						
6461						431
						
8021-68						1197
8023						1197
8816						8800
8820						8800
8821						8800

Document numérisé
 et mis à disposition
 sur plongheure.com

Tiges spéciales
Sonderwellen
Special stems
Tijas especiales
Tiges especiais
Alberi speciali

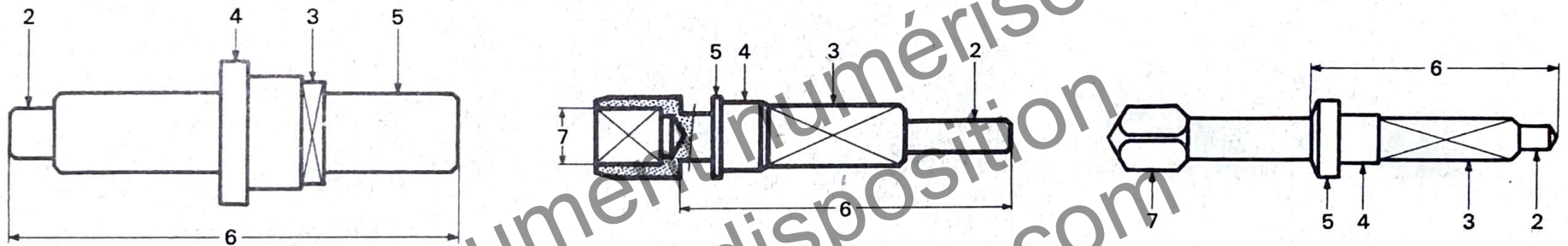

Particularité:

Page 5.4, cal. Valjoux, les numéros entre parenthèses représentent le genre de l'exécution.

Besonderheit:

Seite 5.4, Kaliber Valjoux, die Nummern in Klammer stellen die Art der Ausführung dar.

Particularity:

Page 5.4, calibre Valjoux, the numbers in parentheses show the kind of execution.

Particularidad:

Página 5.4, calibre Valjoux, los números entre parentesis representan el genero de l'ejecución.

Particularidade:

Página 5.4, calibre Valjoux, os números entre parêntesis indicam o género da execução.

Particolarità:

Pagina 5.4, calibro Valjoux, i numeri tra parentesi rappresentano il genere dell'esecuzione.

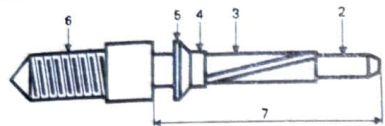

1	2	3	4	5	6	7	8		
	mm	mm	mm	mm	mm	mm			
2641	0,35	0,50	0,63	1,10	0,90	4,13	2651	2661	2671
2651							2641		
2661							2641		
2671							2641		
2763	0,50	0,73	0,90	1,20	0,90	5,20	2764	2766	2769
							2783	2784	2789
							2790		
2764							2763		
2766							2763		
2769							2763		
2783							2763		
2784							2763		
2789							2763		
2790							2763		
2802	0,40	0,50	0,63	1,10	0,90	5,20	2803	2804	2805
							2806	2807	2808
							2809	2810	2811
							2812	2813	2822
							2823	2824	2825

	1	2	3	4	5	6	7	8		
		mm	mm	mm	mm	mm	mm			
										
	2802							2826	2827	2828
								2829	2830	2831
								2832	2833	
	2803							2802		
	2804							2802		
	2805							2802		
	2806							2802		
	2807							2802		
	2808							2802		
	2809							2802		
	2810							2802		
	2811							2802		
	2812							2802		
	2813							2802		
	2822							2802		
	2823							2802		
	2824							2802		
	2825							2802		
	2826							2802		

	1	2	3	4	5	6	7	8
		mm	mm	mm	mm	mm	mm	
								
	2827							2802
	2828							2802
	2829							2802
	2830							2802
	2831							2802
	2832							2802
	2833							2802

Document numérisé
et mis à disposition
sur plongheure.com

Tiges fendues
Geschlitzte Wellen
Split stems
Tijas hendidas
Tiges fendidas
Alberi spaccati

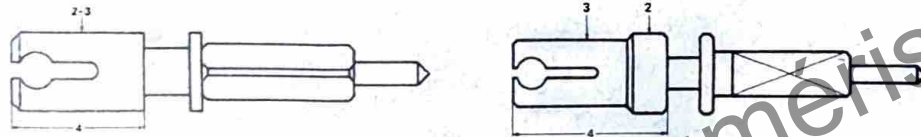

Document numérisé
et mis à disposition
sur plongheure.com

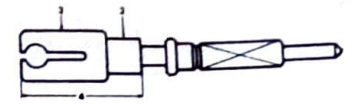
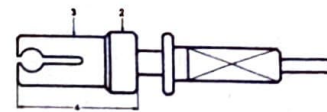
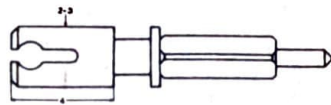

1	2	3	4	5	1	2	3	4	5
	mm	mm	mm			mm	mm	mm	
1920	1,10	1,10	4,37		2638				2600
1930				1475 (+ REV)	2638 R				2600
1931				1475 (+ REV)	2722				2600
1977				1012 INTD 1977	2724				2600
					2732				2600
2451 (2)	1,20	1,20	5,20	≠ 2451					
2600	1,10	1,10	3,65	2602 2608 2612 2618 2620 2620 R 2622 2622 R 2638 2638 R 2722 2724 2732					
2602				2600					
2608				2600					
2612				2600	4750	1,30	1,30	1,34	
2618				2600					
2620				2600					
2620 R				2600					
2622				2600					
2622 R				2600					

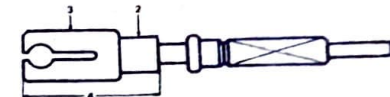
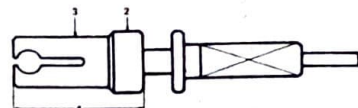
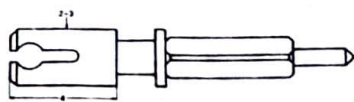

1	2	3	4	5	1	2	3	4	5		
	mm	mm	mm			mm	mm	mm		mm	
180	1,40	1,20	3,58	202	8100	1,36	1,30	2,30	8101	8103	8131
202				180					8135	8137	8140
									8141	8143	8171
									8175	8177	
					8101				8100		
					8103				8100		
6311				176	8131				8100		
6311 N				176	8135				8100		
6325				176	8137				8100		
6326				176	8140				8100		
6411				176	8141				8100		
6411 N				176	8143				8100		
6425				176	8171				8100		
6426				176	8175				8100		
					8177				8100		
					8320-67				8340-67		
					8321-67				8340-67		
					8330-67				8340-67		
					8331-67				8340-67		

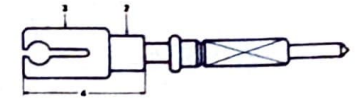
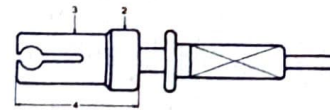
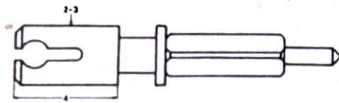

1	2	3	4	5			1	2	3	4	5
	mm	mm	mm					mm	mm	mm	
8340-67	1,60	1,30	2,30	8320-67	8321-67		8451				8450
				8330-67	8331-67		8454				8450
				8341-67	8350-67		8455				8450
				8361-67	8364-67		8456				8450
				8367-67	8370-67		8460				8450
				8381-67			8461				8450
8341-67				8340-67			8464				8450
8350-67				8340-67			8465				8450
8361-67				8340-67			8466				8450
8364-67				8340-67			8467				8450
8367-67				8340-67			8480				8450
8370-67				8340-67			8481				8450
8381-67				8340-67			8484				8450
8422	1,80	1,75	3,63	8423	8428	8429	8485				8450
				8490	8491	8494					
				8495	8496	8497					
8423				8422			8486				8450
8428				8422			8487				8450
8429				8422			8490				8422
8450	1,80	1,75	2,10	8451	8454	8455	8491				8422
				8456	8460	8461					
				8464	8465	8466					
				8467	8480	8481					
				8484	8485	8486					
				8487							
				8494			8495				8422

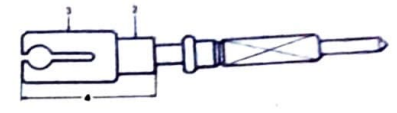
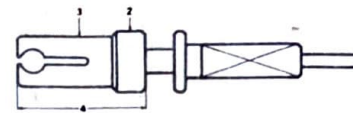
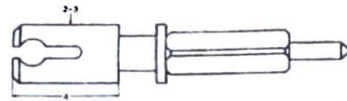

1	2	3	4	5			1	2	3	4	5
	mm	mm	mm					mm	mm	mm	
8496				8422			232				23
8497				8422			234				23
8800	1,30	1,30	2,30	8801	8802	8803	235				23
				8804	8805	8806	236				23
				8810	8811	8813	237				23
				8814	8815	8816	725				23
				8820	8821		726				23
8801				8800			729				23
8802				8800			730				23
8803				8800			7730	1,40	1,30	3,10	7732 - 7733 - ☆ 150 7734 - 7736
8804				8800			7732				7730
8805				8800			7733				7730
8806				8800			7734				7730
8810				8800			7736				7730
8811				8800							
8813				8800							
8814				8800							
8815				8800							
8816				8800							
8820				8800							
8821				8800							

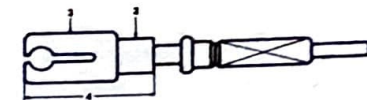
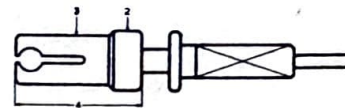
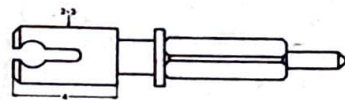

1	2	3	4	5			1	2	3	4	5
	mm	mm	mm					mm	mm	mm	
69-21	1,20	1,30	2,26	FHF 60	INT S 69-21						
75				1977							
450	1,30	1,30	1,99	450-2 451-2	450-3 451-3	451					
450-2				450							
450-3				450							
451				450							
451-2				450							
451-3				450							
471	1,30	1,30	4,15	471-2	471-3	471-4					
471-2				471							
471-3				471							
471-4				471							
1977	1,36	1,30	2,20	75	AS 1012						
36	1,20	1,20	3,38	362	FHF 63						
362				36							

Tiges à bec
Wellen mit Zunge
Beaked stems
Tijas de pico
Tiges de bico
Alberi a becco

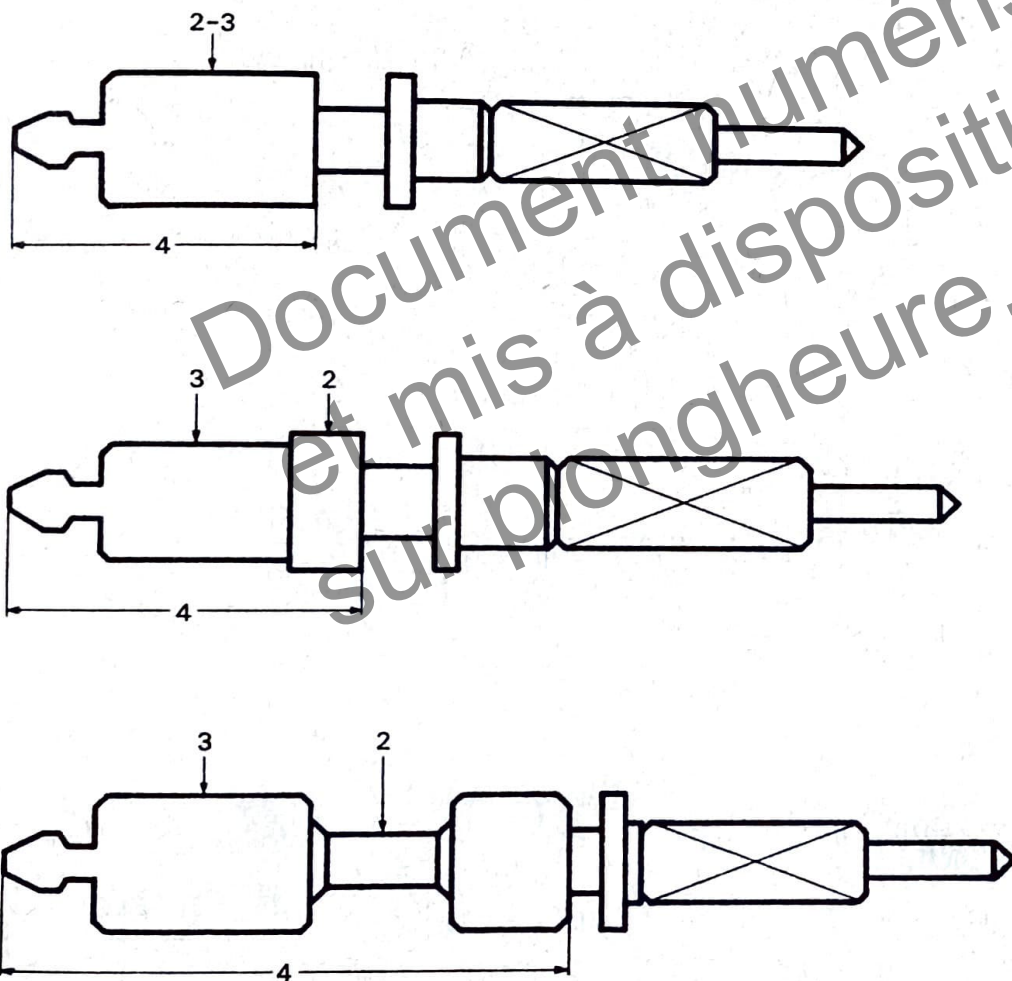

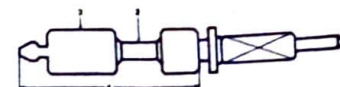
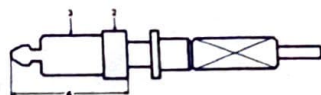
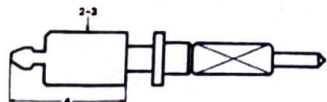

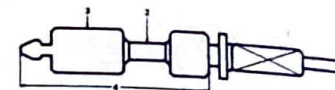
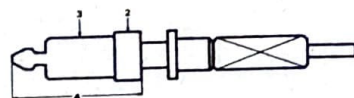
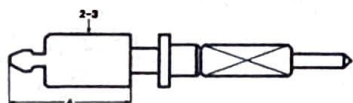

1	2	3	4	5			1	2	3	4	5		
	mm	mm	mm					mm	mm	mm			
1780	1,20	1,20	1,55	1781	1782	1783	67	1,30	1,30	2,68	67-2	67-2 N	67-4
1781				1780							675	675-4	
1782				1780			67-2				67		
1783				1780			67-2 N				67		
1911				1916			67-4				67		
1913				1916			90-4				90-5		
1914				1916			90-5	1,08	1,20	3,72	90-4	90-9	905
1916	1,20	1,20	2,00	1911	1913	1914					908		
1920	1,10	1,10	3,47				90-9				90-5		
1940				1800			97	1,40	1,30	3,68	974	ST 97	
1941				1800			351				34		
1950				1800			352				34		
1951				1800			675				67		
1981				1831			675-4				67		
1983				1831			905				90-5		
1986				1831			908				90-5		
							974				97		

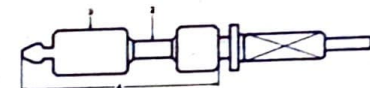
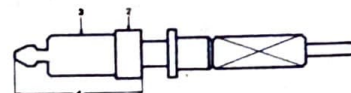
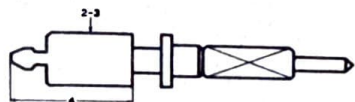

1	2	3	4	5			1	2	3	4	5			
	mm.	mm	mm					mm	mm	mm				
2370	1,40	1,30	2,60	2373	2375	2377	2724				2600			
				2378			2728				2600			
2373				2370			2732				2600			
2375				2370			2734				2600			
2377				2370			2738				2600			
2378				2370			2750	1,20	1,20	2,95	2751	2752	2754	
2570 (1)	1,10	1,10	1,65	≠ 2570 (2)	2580						2758	2760	2762	
2570 (2)	1,10	1,10	1,65	2580							2768	2770	2771	
2580				2570							2772	2773	2774	
2612				2600							2776	2778	2779	
2618				2600							2780	2782	2788	
2623	1,10	1,10	3,85	2623 R			2751				2750			
2623 R				2623			2752				2750			
2639				2600			2754				2750			
2639 R				2600			2758				2750			
2640	1,10	1,10	2,10	2650	2660	2670	2760				2750			
2650				2640			2762				2750			
2660				2640			2768				2750			
2670				2640			2770				2750			
2722				2600			2771				2750			
							2772				2750			
							2773				2750			



1	2	3	4	5	1	2	3	4	5
	mm	mm	mm			mm	mm	mm	
2774				2750	6485				6360
2776				2750	6485 N				6360
2778				2750	6486				6360
2779				2750	6486 N				6360
2780				2750	6487				6360
2782				2750	6488				6360
2788				2750					
									
6360	1,10	1,10	1,80	6365 6365 N 6470 6475 6476 6480 6480 N 6485 6485 N 6486 6486 N 6487 6488	6660	1,40	1,40	1,80	6662
6365				6360	6662				6660
6365 N				6360					
6470				6360					
6475				6360					
6476				6360					
6480				6360					
6480 N				6360					

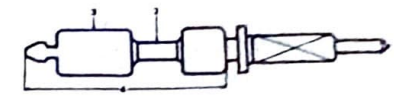
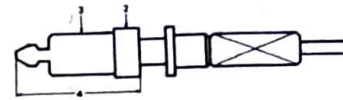
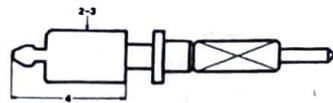

1	2	3	4	5	1	2	3	4	5
	mm	mm	mm			mm	mm	mm	
7030				7020	8370				8350
7034				7020	8374-66				8350
7057				7040	8381				8350
7070	1,20	1,20	4,27	7076 7077	8381-66				8350
7076				7070	8385-66				8350
7077				7070	8387-66				8350
					8391-66				8350
8320				8350	8395-66				8350
8320-66				8350	8397-66				8350
8321				8350	8398				8350
8321-66				8350	8399				8350
8330-66				8350					
8331-66				8350					
8340				8350					
8340-66				8350					
8341				8350					
8341-66				8350					
8360				8350					
8364				8350					

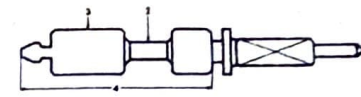
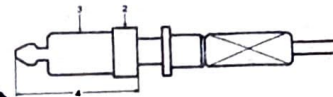
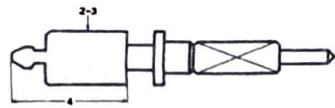

1	2	3	4	5			1	2	3	4	5			
	mm	mm	mm					mm	mm	mm				
450	1,30	1,30	1,99	450-2	450-3	451	7410	1,20	1,20	3,14	7411	7412	7420	
				451-2	451-3	471						7421	7422	7423
				471-2	471-3	471-4			1,20	1,20	3,10	7424	7425	7426
												7427	7428	7520
450-2				450							7521	7522	7523	
450-3				450							7524	7525	7526	
451				450							7527	7528		
451-2				450			7411				7410			
451-3				450			7412				7410			
471				450			7420				7410			
471-2				450			7421				7410			
471-3				450			7422				7410			
471-4				450			7423				7410			
600				601			7424				7410			
601	1,10	1,10	4,49	600	605	606	7425				7410			
				610	611	615	7426				7410			
				616			7427				7410			
605				601			7428				7410			
606				601			7520				7410			
610				601			7521				7410			
611				601			7522				7410			
615				601			7523				7410			
616				601							7410			

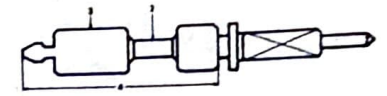
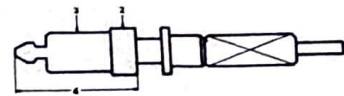
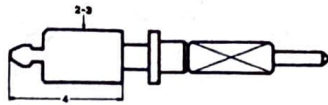

1	2	3	4	5	1	2	3	4	5
	mm	mm	mm			mm	mm	mm	
7524				7410					
7525				7410					
7526				7410					
7527				7410					
7528				7410					

Document numérisé
et mis à disposition
sur plongneure.com

Remplace les N^{os} 1 et 2

ERRATA

Veuillez modifier votre catalogue comme suit:

Page 1.19 (2^e colonne)

Remplacer 2551 R par **2551**

Page 3 (verte)

Pour ce secteur l'explication du signe (\neq) n'a pas été mentionnée, sa signification est la suivante (identique à la page verte 6):
Malgré les mêmes dimensions indiquées, les tiges ne sont pas interchangeables.

Page 3.9

Remplacer (+ REV 3) par (+ REV 4)

Page 4.3

Modifier les concordances (colonne 7) du calibre UT 285 comme suit:

233	234	286	444
497	498	6497	6500
6503	(\neq 6498)		

Page 4.4

Calibre 6498 à compléter comme suit:

1	2	3	4	5	6	7
6498	0,50	0,90	1,40	1,20	8,35	(\neq 285)

Page 6.4 colonne N° 1 (la seconde)

Remplacer 1399 par **1393**

Page 6.7 colonne N° 1 (la première)

Remplacer 1920 par **1820**

Die Nrn. 1 und 2 ersetzen

ERRATA

Bitte Ihr Katalog folgendermassen ändern:

Seite 1.19 (2. Kolonne)

2551R ersetzen durch **2551**

Seite 3 (grün)

Für diesen Sektor ist die Erläuterung des Zeichens (\neq) nicht erwähnt, seine Bedeutung ist die folgende (identisch mit der grünen Seite 6): Trotz den gleichen angegebenen Dimensionen sind die Wellen nicht austauschbar.

Seite 3.9

(+ REV 3) ersetzen durch (+ REV 4)

Seite 4.3

Die Übereinstimmungen (Kolonne 7) des Kalibers UT 285 folgendermassen ändern:

233	234	286	444
497	498	6497	6500
6503	(\neq 6498)		

Seite 4.4

Kaliber 6498 folgendermassen ergänzen:

1	2	3	4	5	6	7
6498	0,50	0,90	1,40	1,20	8,35	(\neq 285)

Seite 6.4 Kolonne Nr. 1 (die zweite)

1399 ersetzen durch **1393**

Seite 6.7 Kolonne Nr. 1 (die erste)

1920 ersetzen durch **1820**

Replace the Nos. 1 and 2

ERRATA

Please make the following alterations on your catalogue:

Page 1.19 (2nd column)

Replace 2551R by **2551**

Page 3 (green)

For this sector, the explanation of the sign \neq has not been mentioned; its meaning is the following (identical with green page 6):
Despite the fact that the same dimensions are indicated, the stems are not interchangeable.

Page 3.9

Replace (+ REV 3) by (+ REV 4)

Page 4.3

Alter the concordances (column 7) of caliber UT 285 as follows:

233	234	286	444
497	498	6497	6500
6503	(\neq 6498)		

Page 4.4

Caliber 6498 to be completed as follows:

1	2	3	4	5	6	7
6498	0,50	0,90	1,40	1,20	8,35	(\neq 285)

Page 6.4 column No. 1 (the second)

Replace 1399 by **1393**

Page 6.7 column No. 1 (the first)

Replace 1920 by **1820**

Reemplazar los N.^{os} 1 y 2

ERRATA

Sírvase modificar su catálogo conforme indicado:

Página 1.19 (segunda columna)

Reemplazar 2551 R por **2551**

Página 3 (verde)

Para este sector, la explicación del signo (\neq) no ha sido dada. Su significado es el siguiente (idéntico al de la página verde 6):
A pesar de las mismas dimensiones indicadas, las tijas no son intercambiables.

Página 3.9

Reemplazar (+ REV 3) por (+ REV 4)

Página 4.3

Modificar las concordancias (columna 7) del calibre UT 285 de la manera siguiente:

233	234	286	444
497	498	6497	6500
6503	(\neq 6498)		

Página 4.4

Calibre 6498 debe ser completado de la manera siguiente:

1	2	3	4	5	6	7
6498	0,50	0,90	1,40	1,20	8,35	(\neq 285)

Página 6.4 columna N.^o 1 (la segunda)

Reemplazar 1399 por **1393**

Página 6.7 columna N.^o 1 (la primera)

Reemplazar 1920 por **1820**

Substituir N.º. 1 + N.º. 2

ERRATA

Favor modificar vosso catálogo da seguinte maneira:

Página 1.19 (2a. coluna)

Substituir 2551 R por **2551**

Página 3 (verde)

Para este sector, a explicação do sinal (\neq) não foi mencionada; o seu significado é o seguinte (idêntico ao da página verde 6): Apesar de serem indicadas as mesmas dimensões, as tiges não são intermutáveis.

Página 3.9

Substituir (+ REV 3) por (+ REV 4)

Página 4.3

Modificar as concordâncias (coluna 7) do calibre UT 285 conforme segue:

233	234	286	444
497	498	6497	6500
6503	(\neq 6498)		

Página 4.4

Calibre 6498, a completar como segue:

1	2	3	4	5	6	7
6498	0,50	0,90	1,40	1,20	8,35	(\neq 285)

Página 6.4 coluna N.º. 1 (a segunda)

Substituir 1399 por **1393**

Página 6.7 coluna N.º. 1 (a primeira)

Substituir 1920 por **1820**

Sostituisse i N° 1 e 2

ERRATA

Vogliate modificare come segue il vostro catalogo:

Pagina 1.19 (seconda colonna)

Sostituire 2551 R con **2551**

Pagina 3 (verde)

Per questo settore la spiegazione del segno (\neq) non è stata menzionata, il suo significato è il seguente (identico alla pagina verde 6): Malgrado le stesse dimensioni indicate, gli alberi non sono intercambiabili.

Pagina 3.9

Sostituire (+ REV 3) con (+ REV 4)

Pagina 4.3

Modificare le concordanze (colonna 7) del calibro UT 285 come segue:

233	234	286	444
497	498	6497	6500
6503	(\neq 6498)		

Pagina 4.4

Calibro 6498 da completare come segue:

1	2	3	4	5	6	7
6498	0,50	0,90	1,40	1,20	8,35	(\neq 285)

Pagina 6.4 colonna N° 1 (la seconda)

Sostituire 1399 con **1393**

Pagina 6.7 colonna N° 1 (la prima)

Sostituire 1920 con **1820**