

Supplément No 3
Mise à jour au 31. 12. 1971
Remplace N° 1 et 2

Nachtrag Nr. 3
Stand am 31. 12. 1971
Die Nummern 1 und 2 ersetzen

Supplement No. 3
Brought up to date the 31. 12. 1971
Replace the No 1 and 2

Supplemento No 3
Aggiornamento al 31. 12. 1971
Sostituire i Ni 1 e 2

Suplemento No 3
Puesto al corriente el 31. 12. 1971
Reemplazar los N.º 1 y 2

Suplemento No 3
Pôsto em dia 31. 12. 1971
Substituir N° 1 + N° 2

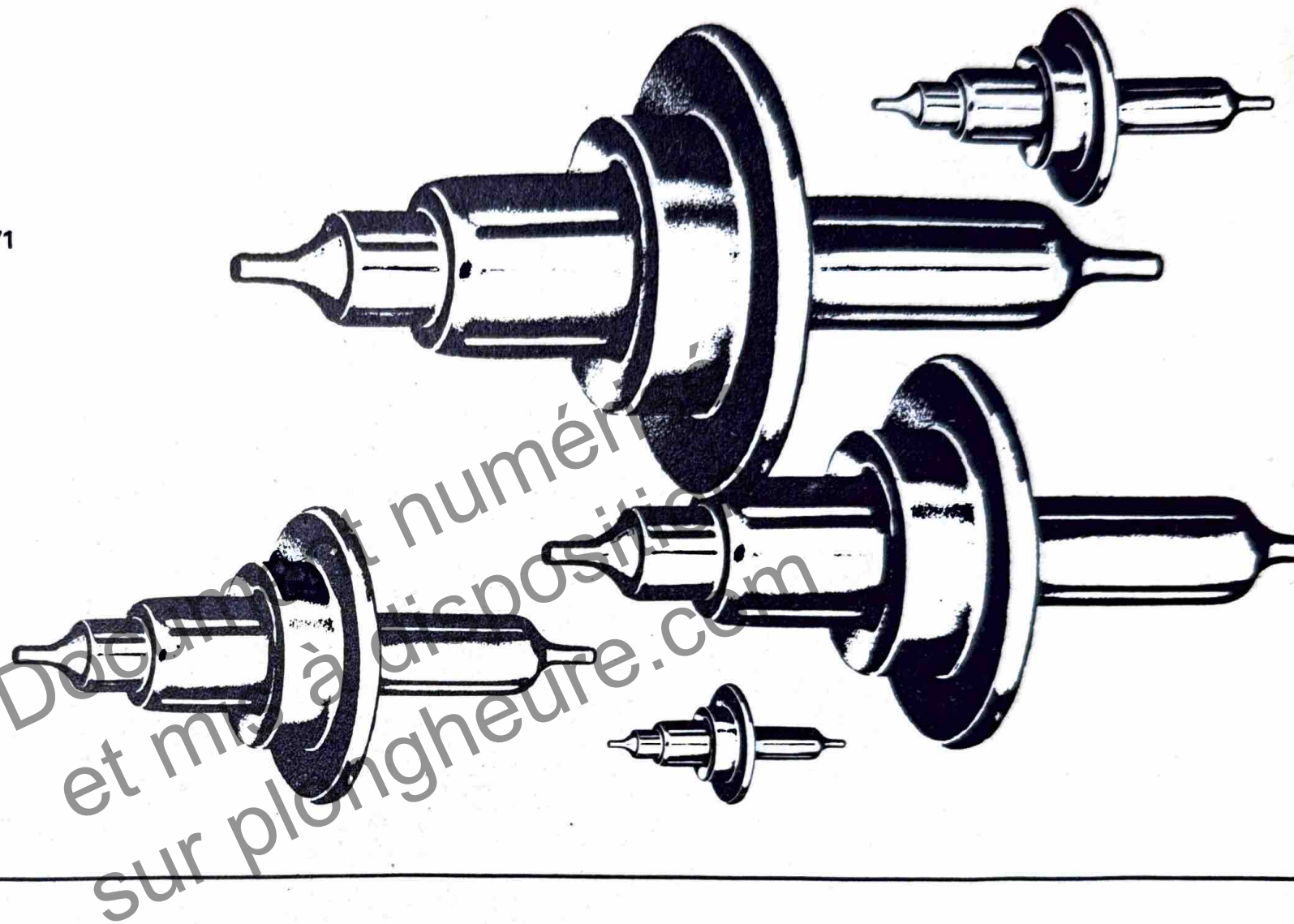

EBAUCHES SA

2001 NEUCHÂTEL SUISSE

Classement des axes par genre et par hauteur totale
Einteilung der Wellen nach Art und nach Gesamthöhe
Classification of staffs according to type and total height

Important Les dimensions sont données en centième de millimètre

Wichtig Die Masse sind in Hundertstelmmillimetern angegeben

Important The dimensions are given in hundredths of a millimeter

genre d'axes / Unruhwellengattung / type of balance staffs

maison affiliée / Tochtergesellschaft / affiliated company

référence du calibre / Kaliber-Referenz / caliber reference number

numéro de l'exécution (certains calibres sont équipés d'axes du même type mais de dimensions différentes)

Nummer der Ausführung (bestimmte Kaliber sind mit Unruhwellen der gleichen Gattung, aber unterschiedlicher Abmessungen ausgerüstet)

execution number (some calibers are provided with balance staffs of the same type but of different dimensions)

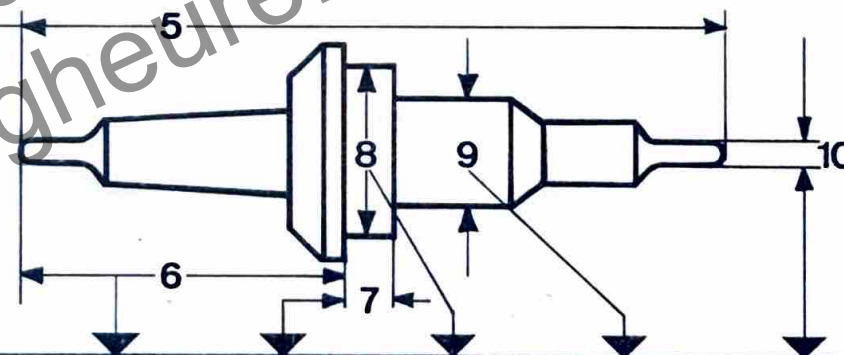

1	2	3	4	5	6	7	8	9	10
P	7000	2	.	212	100	20	90	60	8
P	7000	2	..	212	100	20	80	60	8

Texto español: ver en página siguiente.

Texto português: ver na página seguinte.

Testo italiano: vedere la pagina seguente.

Clasificación de los ejes por género y por altura total
Classificação dos eixos por género e altura total
Classifica degli assi per genere e per altezza totale

Importante Las dimensiones se dan en centésimos de milímetro

Importante As dimensões são indicadas em centésimos de milímetro

Importante Le dimensioni sono date in centesimi di millimetro

tipo de ejes / tipo do eixo / tipo di alberi

casa afiliada / fábrica asociada / ditta affiliata

referencia del calibre / referência do calibre / referenza del calibro

número de la ejecución (ciertos calibres están equipados con ejes del mismo tipo pero de dimensiones diferentes)

número de execução (alguns calibres são equipados com eixos do mesmo tipo, mas de dimensões diferentes)

numero dell'esecuzione (certi calibri sono muniti di alberi dello stesso tipo ma di dimensioni differenti)

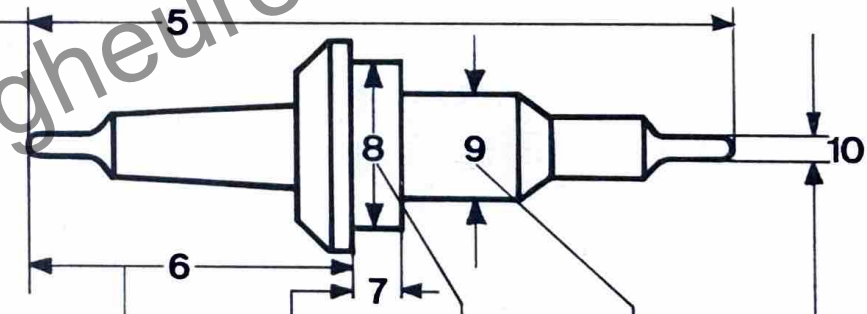

1	2	3	4	5	6	7	8	9	10
P	7000	2	.	212	100	20	90	60	8
P	7000	2	..	212	100	20	80	60	8

Texte français: voir page précédente.

Deutscher Text: siehe vorherige Seite.

English text: see the previous page.

724-728

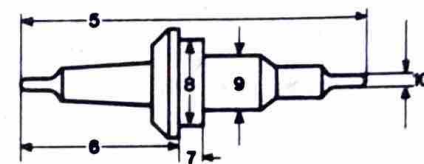

1	2	3	4	5	6	7	8	9	10
P	7001		..	220	108	20	80	60	8
ETA	2640		..	271	148	18	70	45	7
FEF	6670		..	275	153	20	80	48	8
F	4550	2	..	275	147	25	100	60	10
ETA	2722		..	276	146	22	90	45	8
ETA	2732		..	276	146	20	80	45	8
ETA	2800		..	276	146	22	90	45	9
ETA	2804		..	276	146	22	90	45	8
ETA	2819		..	276	146	20	80	45	8
FHF	37		..	277	143	18	70	45	8
AV	4820		..	277	149	22	90	50	8
AV	4830		..	277	149	20	80	50	8
INT D	1977		..	279	142	18	70	50	7
INT D	69-21		..	280	137	18	70	45	8
AS	1920		..	283	144	20	80	45	7
AS	2060		..	286	152	22	90	50	9
AS	2160		..	296	165	22	90	45	8
ETA	2750		..	306	154	25	100	50	9
ETA	2751		..	306	154	22	90	50	8
FHF	97		..	314	159	22	90	45	9
ST	97		..	314	159	22	90	45	9

729/1

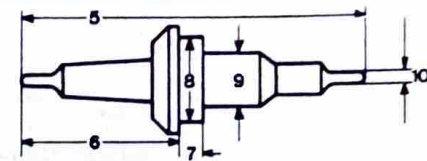

1	2	3	4	5	6	7	8	9	10
F	4130		..	240	118	18	70	30	7
P	7040		..	254	131	20	80	35	8
FHF	34-21		..	255	131	18	70	30	8
P	320		::	267	135	24	90	35	8
ETA	2412		::	270	149	20	70	35	7
FHF	90-5		..	272	136	20	80	35	9
FEF	371N		::	280	135	22	80	35	8
FEF	6680		..	285	132	20	80	35	8
F	4057		::	288	156	22	80	35	8
FEF	6660		..	290	139	20	80	35	8
FHF	63		::	292	139	22	80	35	8
AS	1940		..	295	160	22	90	35	9
FEF	250		::	297	155	22	80	35	8
FHF	55		..	303	167	22	90	30	9
ETA	2370		.	307	165	30	100	35	9
ETA	2370		..	307	165	25	100	35	9
UT	176		.	313	156	30	100	30	10
UT	6310		.	313	156	30	100	35	10
UT	6310		..	313	156	25	100	35	10
UT	6310N		..	313	156	25	100	35	10
FHF	97		..	314	159	22	90	35	9

729/1

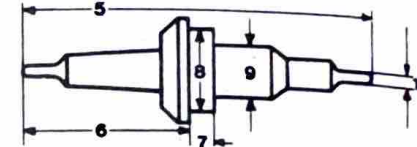

1	2	3	4	5	6	7	8	9	10
ST	97		..	314	159	22	90	35	9
AS	1130		.	315	155	30	100	35	10
AS	1130		..	315	155	25	100	35	10
RF	7733		..	347	165	25	100	50	10

821

1	2	3	4	5	6	7	8	9	10
EB	8423			315	219		60	60	9

829

Virole «Berthoud» – Spiralrolle «Berthoud» – «Berthoud» collet fitting – virola «Berthoud»

1	2	3	4	5	6	7	8	9	10
EB	8800		..	343	188		63	35	10

Classement des axes par maisons et calibres Klassierung der Unruhwellen nach Firmen und nach Kalibern Classification of balance staffs according to companies and calibers

Important Les dimensions sont données en centième de millimètre
Wichtig Die Masse sind in Hundertstelmillimetern angegeben
Important The dimensions are given in hundredths of a millimeter

maison affiliée / Tochtergesellschaft / affiliated company
 référence du calibre / Kaliber-Referenz / caliber reference number



numéro de l'exécution (certains calibres sont équipés d'axes du même type mais de dimensions différentes)
 Nummer der Ausführung (bestimmte Kaliber sind mit Unruhwellen der gleichen Gattung, aber unterschiedlicher Abmessungen ausgerüstet)
 execution number (some calibers are provided with balance staffs of the same type but of different dimensions)

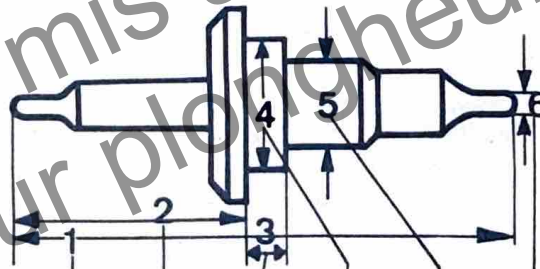

l'axe 724 ou 728 remplace l'axe 723 mais pas l'inverse
 Die Welle 724 oder 728 ersetzt die Welle 723, aber nicht umgekehrt
 balance staff 724 or 728 can be substituted for staff 723, but not vice versa

calibres dont l'axe est identique
 Kaliber, deren Welle identisch ist
 calibers with identical balance staffs

AS	Calibre	Vis ann.	Genre	ex.	1	2	3	4	5	6	∞	Interchangeabilité
	340	.	723	1	363	185	25	85	55	11½		
	.	723	2	363	185	25	85	55	10	∞		516 806 922 1004

Texto español: ver en página siguiente.

Texto português: ver na página seguinte.

Testo italiano: vedere la pagina seguente.

Clasificación de los ejes por casas y por calibres
Classificação dos eixos por fábricas e por calibre
Classificazione degli alberi per ditte e per calibri

Importante Las dimensiones se dan en centésimos de milímetro

Importante As dimensões são indicadas em centésimos de milímetro

Importante Le dimensioni sono date in centesimi di millimetro

casa afiliada / fábrica asociada / ditta affiliata

referencia del calibre / referência ou calibre / referenza del calibre



tipo de ejes / tipo do eixo / tipo di alberi

número de la ejecución (ciertos calibres están equipados con ejes del mismo tipo pero de dimensiones diferentes)

número de execução (alguns calibres são equipados com eixos do mesmo tipo, mas de dimensões diferentes)

numero dell'esecuzione (certi calibri sono muniti di alberi dello stesso tipo ma di dimensioni differenti)

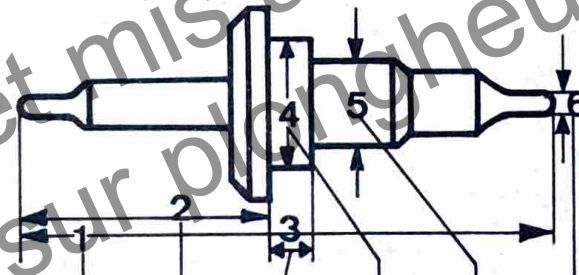

el eje 724 ó 728 reemplaza el eje 723 pero no viceversa

o eixo 724 ou 728 substitui o eixo 723, mas o inverso não é possível

l'albero 724 o 728 sostituisce l'albero 723 ma non il contrario

calibres en los cuales el eje es idéntico
 calibres cujo eixo é idéntico
 calibri il cui asse è identico

AS	Calibre	Vis ann.	Genre	ex.	1	2	3	4	5	6	∞	Interchangeabilité
	340	.	723	1	363	185	25	85	55	11½		
	.	723	2	363	185	25	85	55	10	∞		516 806 922 1004

Texte français: voir page précédente.

Deutscher Text: siehe vorherige Seite.

English text: see the previous page.

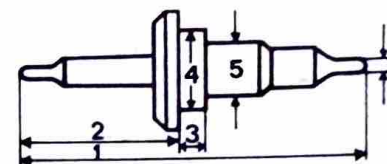

Calibre	Vis ann.	Genre	ex.	1	2	3	4	5	6	∞	Interchangeabilité
1130	.	729/1		315	158	30	100	35	10		
	..	729/1		315	158	25	100	35	10		
1677	..	729									1012
1911	..	723									1900
	..	728									1900
1913	..	723									1900
	..	728									1900
1914	..	723									1900
	..	728									1900
1916	..	723									1900
	..	728									1900
1920	..	728		283	144	20	80	45	7		
1930	..	728		320	154	20	80	50	9		1931
1931	..	728									1930
1940	..	729/1		295	160	22	90	35	9		1941 1950 1951 ST1940
1941	..	729/1									1940
1950	..	729/1									1940
1951	..	729/1									1940
1977	..	723									976 INT D 1977
	..	728									976 INT D 1977
1978	..	723									976
	..	728									976
1981	..	728									1880
1983	..	728									1880
1985	..	728									1880
1986	..	728									1880
1993	..	728									1880
1995	..	728									1880
1996	..	728									1880

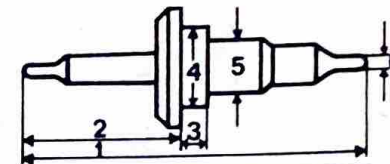

Calibre	Vis ann.	Genre	ex.	1	2	3	4	5	6	∞	Interchangeabilité
34-21	..	729/1		255	131	18	70	30	8		
37	..	728		277	143	18	70	45	8		374 378
55	..	729/1		303	167	22	90	30	9		
63	::	729/1		292	139	22	80	35	8		
90-4	..	728									90-5
	..	729/1									90-5
90-5	..	729/1		272	136	20	80	35	9		90-4 90-9 905 908
90-9	..	728									90-5
	..	729/1									90-5
97	..	728		314	159	22	90	45	9		974 ST97
	..	729/1		314	159	22	90	35	9		974
351	..	728									35
352	..	728									35
374	..	728									37
378	..	728									37
905	..	728									90-5
	..	729/1									90-5
908	..	728									90-5
	..	729/1									90-5
974	..	728									97
	..	729/1									97

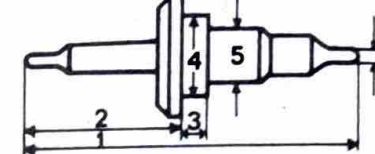

Calibre	Vis ann.	Genre	ex.	1	2	3	4	5	6	∞	Interchangeabilité
2370	.	729/1		307	165	30	100	35	9		2373 2375 2377 2378
	..	729/1		307	165	25	100	35	9		2373 2375 2377 2378
2373	::	729/1									2370
2375	::	729/1									2370
2377	::	729/1									2370
2378	::	729/1									2370
2412	.	729/1		270	149	20	75	35	7		
	..	729/1		270	149	18	70	35	7		
2612	::	728									2600
2618	..	728									2600
2630	::	728									2600
2632	::	728									2600
2640	..	728		271	148	18	70	45	7		2641 2650 2651 2660 2661 2670 2671
2641	..	728									2640
2650	..	728									2640
2651	..	728									2640
2660	..	728									2640
2661	..	728									2640
2670	..	728									2640
2671	..	728									2640
2722	..	728		276	146	22	90	45	8		2724 2728
2724	..	728									2722
2728	..	728									2722
2732	..	728		276	146	20	80	45	8		2734 2738
2734	..	728									2732
2738	..	728									2732

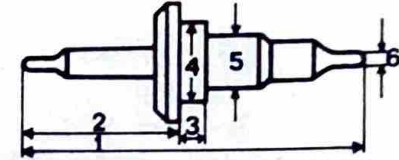

Calibre	Vis ann.	Genre	ex.	1	2	3	4	5	6	∞	Interchangeabilité
2750	..	728		306	154	25	100	50	9		2752 2758 2762 2763 2768 2769 2770 2772 2773 2776 2778 2779 2782 2783 2788 2789
2751	..	728		306	154	22	90	50	8		2754 2760 2764 2766 2771 2774 2780 2784 2790
2752	..	728									2750
2754	..	728									2751
2758	..	728									2750
2760	..	728									2751
2762	..	728									2750
2763	..	728									2750
2764	..	728									2751
2766	..	728									2751
2768	..	728									2750
2769	..	728									2750
2770	..	728									2750
2771	..	728									2751
2772	..	728									2750
2773	..	728									2750
2774	..	728									2751
2776	..	728									2750
2778	..	728									2750
2779	..	728									2750
2780	..	728									2751
2782	..	728									2750
2783	..	728									2750
2784	..	728									2751
2788	..	728									2750

Document numérisé
et mis à disposition
sur plongheure.com

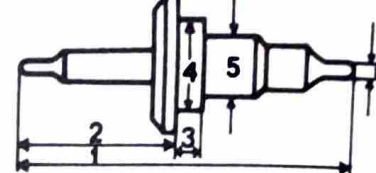

Calibre	Vis ann.	Genre	ex.	1	2	3	4	5	6	∞	Interchangeabilité
2789	..	728									2750
2790	..	728									2751
2800	..	728		276	146	22	90	45	9		2802 2803 2808 2809 2820 2822 2823 2828 2829
2801	..	728									2804
2802	..	728									2800
2803	..	728									2800
2804	..	728		276	146	22	90	45	8		2801 2805 2810 2811 2821 2824 2825 2830 2831
2805	..	728									2804
2806	..	728									2819
2807	..	728									2819
2808	..	728									2800
2809	..	728									2800
2810	..	728									2804
2811	..	728									2804
2812	..	728									2819
2813	..	728									2819
2819	..	728		276	146	20	80	45	8		2806 2807 2812 2813 2826 2827 2832 2833 2839
2820	..	728									2800
2821	..	728									2804
2822	..	728									2800
2823	..	728									2800
2824	..	728									2804
2825	..	728									2804
2826	..	728									2819
2827	..	728									2819
2828	..	728									2800

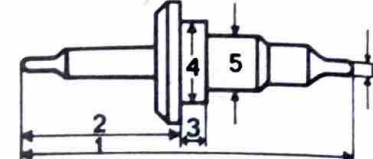

Calibre	Vis ann.	Genre	ex.	1	2	3	4	5	6	∞	Interchangeabilité
4820	..	728		277	149	22	90	50	8		
4830	..	728		277	149	20	80	50	8		
176	.	729/1		313	156	30	100	30	10		
6308	..	728									6300N
6310	.	729/1		313	156	30	100	35	10		
	..	729/1		313	156	25	100	35	10		
6310N	..	729/1		313	156	25	100	35	10		
6311	.	723									176
	..	723									6310
	.	724									176
	..	724									6310
6311N	..	728								6310N	
6325	..	728								6310N	
6326	..	728								6310N	
6411	.	723									176
	..	723									6310
	.	724									176
	..	724									6310
6411N	..	728								6310N	
6425	..	728								6310N	
6426	..	728								6310N	
6487	..	728								6365N	
6488	..	728								6365N	

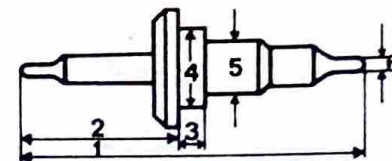

Calibre	Vis ann.	Genre	ex.	1	2	3	4	5	6	∞	Interchangeabilité				
8021-68	..	792									8020				
	..	821									8020				
8023	..	792									8020				
	..	821									8020				
8131	..	821									8340				
8135	..	821									8340				
8137	..	821									8340				
8171	..	821									8340				
8175	..	821									8340				
8177	..	821									8340				
8360	..	821									8340				
8364	..	821									8340				
8371	..	821									8340				
8393-67	..	821									8340				
8398	..	821									8340				
8422	..	821									8423				
8423	..	821		315	219		60	60	8		8422	8428	8429	8450	8451
											8454	8455	8456	8460	8461
											8464	8465	8466	8467	8480
											8481	8484	8485	8486	8487
											8490	8491	8494	8495	8496
											8497				
8428	..	821									8423				
8429	..	821									8423				
8450	..	821									8423				
8451	..	821									8423				
8454	..	821									8423				
8455	..	821									8423				
8456	..	821									8423				

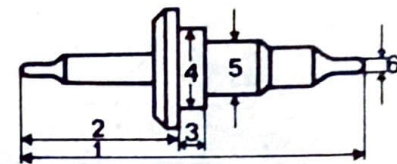

Calibre	Vis ann.	Genre	ex.	1	2	3	4	5	6	∞	Interchangeabilité
232	::	723									23
	::	724									23
234	..	728									236
235	..	728									236
236	..	728		359	179	22	90	50	10		234 235 237 725 726 729 730
237	..	728									236
725	..	728									236
726	..	728									236
729	..	728									236
730	..	728									236
7720	..	728		575	275	35	120	80	11		7721
7721	..	728									7720
7732	..	728									7730
7733	..	728									7730
	..	729/1		347	165	25	100	50	10		7734 7736 7739
7734	..	728									7730
	..	729/1									7733
7736	..	728									7730
	..	729/1									7733
7739	..	728									7730
	..	729/1									7733
7740	..	728		320	163	22	90	50	8		

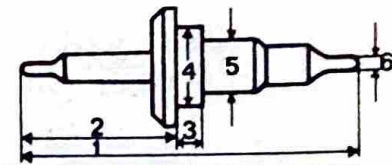

Calibre	Vis ann.	Genre	ex.	1	2	3	4	5	6	∞	Interchangeabilité
69-21	..	728		280	137	18	70	45	8		FHF60-21 INTS69-21
75	..	728									1977
1977	..	728		279	142	18	70	50	7		75 AS976
7410	..	728									451
7411	..	728									451
7412	..	728									451
7420	..	728									451
7421	..	728									451
7422	..	728									451
7423	..	728									451
7424	..	728									451
7425	..	728									451
7426	..	728									451
7427	..	728									451
7428	..	728									451
7520	..	728									451
7521	..	728									451
7522	..	728									451
7523	..	728									451
7524	..	728									451
7525	..	728									451
7526	..	728									451
7527	..	728									451
7528	..	728									451

Document numérisé
 et mis à disposition
 sur plongheure.com

ERRATA

Veillez modifier votre catalogue comme suit:

Ändern Sie bitte Ihren Katalog folgendermassen:

Please make the following alterations on your catalogue:

1. **Page** (5e colonne) Remplacer 215 par 295
Seite 2.1 (5. Kolonne) 215 durch 295 ersetzen
Page (5nd column) Replace 215 by 295

2. **Troisième partie** **Classement des axes par maisons et calibres**
Dritter Abschnitt **Klassierung der Unruhwellen nach Firmen und nach Kalibern**
Third part **Classification of balance staffs according to companies and calibers**

Seulement en anglais:

Nur beim englischen Text:

English text only:

balance staff 724 or 738 can be ...

Remplacer par:

Ersetzen durch:

Replace by:

balance staff 724 or 728 can be ...

3. **Page**
Seite 3.44
Page

Remplacer, ersetzen, replace:

69	..	729/1	280	137	20	80	35	8	ST 69
----	----	-------	-----	-----	----	----	----	---	-------

par, durch, by:

69	..	729/1	280	137	22	80	35	8	ST 69
----	----	-------	-----	-----	----	----	----	---	-------

ERRATA

Sírvase modificar su catálogo conforme como indicado:

Favor modificar vosso catálogo da seguinte maneira:

Vogliate modificare il vostro catalogo come segue:

1. **Página** (5. columna) Reemplazar 215 por 295
Página 2.1 (5a columna) Substituir 215 por 295
Pagina (5a colonna) Sostituire 215 con 295

2. **Tercera parte** **Clasificación de los ejes por casas y por calibres**
Terceira parte **Classificação dos eixos por fábricas e por calibre**
Parte terza **Classificazione degli alberi per ditte e per calibri**

Sólo en el texto inglés:

Sómente dan le texte inglés:

Solamente nel testo inglese:

Reemplazar por:

Substituir por:

Sostituire con:

balance staff 824 or 738 can be ...

balance staff 724 or 728 can be ...

3. **Página**
Página 3.44
Pagina

Reemplazar, substituir, sostituire:

69	..	729/1	280	137	20	80	35	8	ST 69
----	----	-------	-----	-----	----	----	----	---	-------

por, por, con:

69	..	729/1	280	137	22	80	35	8	ST 69
----	----	-------	-----	-----	----	----	----	---	-------